

TWA125

Afmetingen

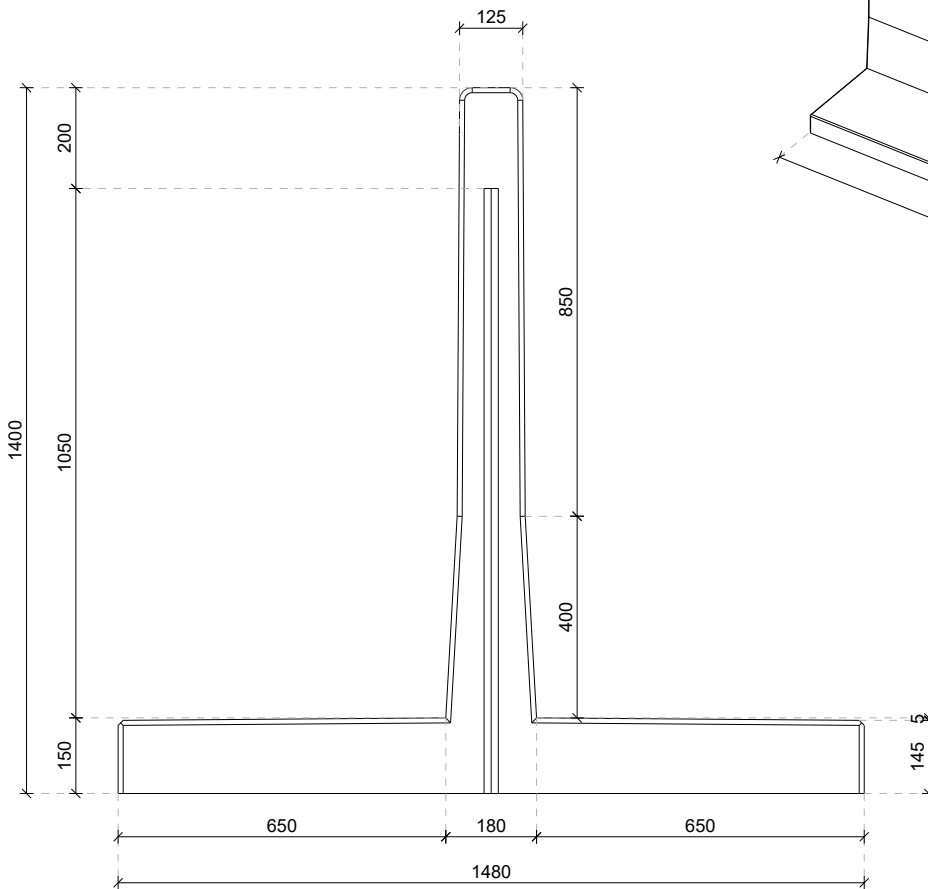

Details

Afgeronde bovenzijde

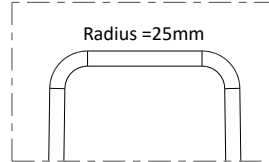

Koppellat-sparing

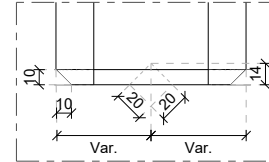

Verbinding elementen

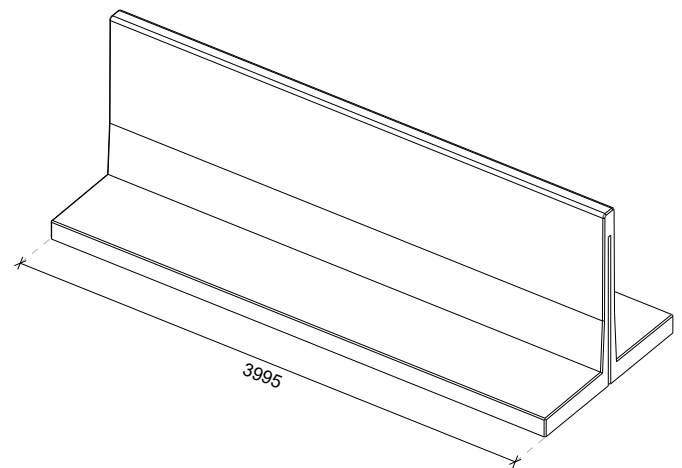
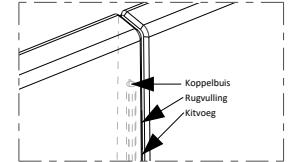

Technische details

Betonreceptuur 2nd Generation self-compacting C60/75
Wapeningsstaal B500
Gewicht 3720kg (L=3995mm)

Betondekking 30mm
Maattolerantie +/-5mm
Zichtbetonklasse Alle zichtzijdes klasse A (B1 op aanvraag)
Hijsvoorziening Geen, plaatsen met klem
Productgarantie 20 jaar
Milieuklasse XA3, XC4, XD3, XS3, XF4
Ontwerplevensduur 50 jaar(XA3, XD3, XS3)
100 jaar(XC4, XF4)

Geconstrueerd conform

NEN-EN 1990 Eurocode 0 NEN-EN 206
NEN-EN 1991 Eurocode 1 NEN 8005
NEN-EN 1992 Eurocode 2 NEN 9997
NEN-EN 1997 Eurocode 7 Incl. nationale bijlagen

Productiewijze



Energie
neutraal



Gefilterd
hemelwater



Duurzame
grondstoffen



Recyclebare
materialen

Certificering

