

TYPE TWA100

Afmetingen

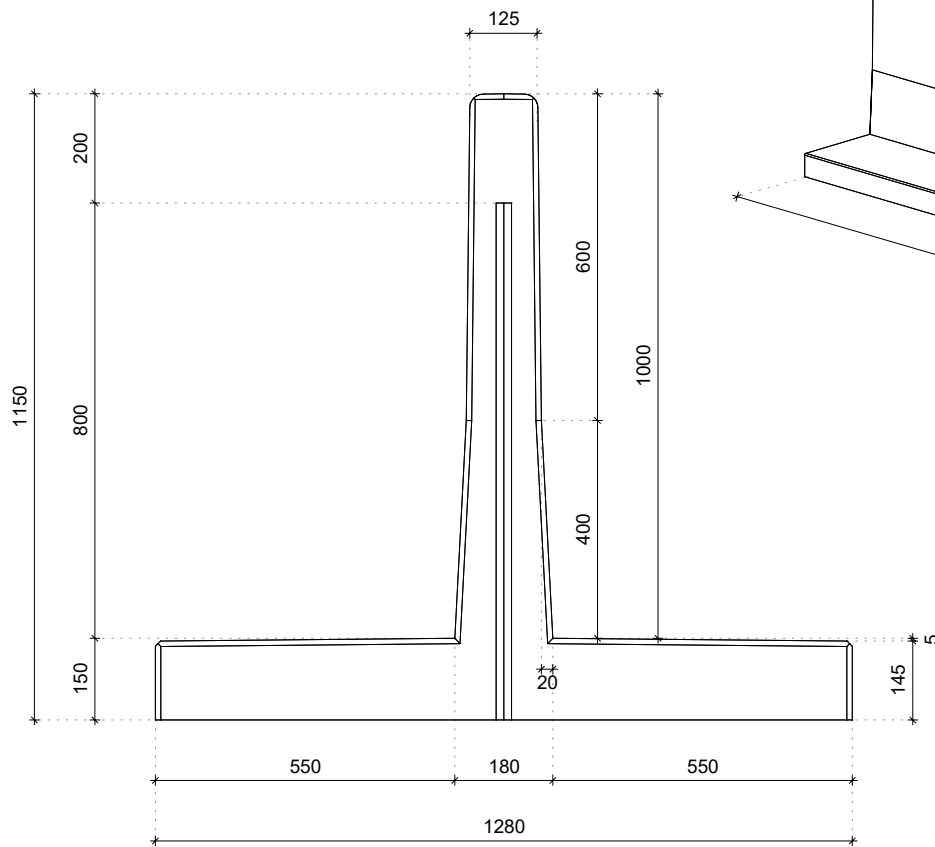

Details

Afgeronde bovenzijde

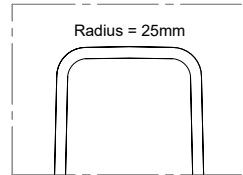

Koppelbuis-sparing

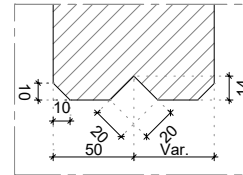

Verbinding elementen

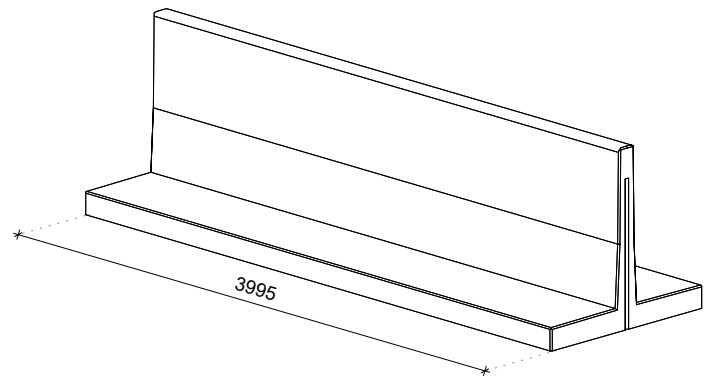
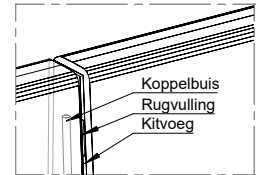

Technische details

Betonkwaliteit	C60/75 (zelfverdichtend hogesterktebeton)
Wapeningsstaal	B500
Gewicht	3100kg (L = 3995mm)
Betondekking	30mm
Maattolerantie	+/- 5mm
Zichtbetonklasse	Alle zichtzijdes klasse A (B1 op aanvraag)
Ontwerplevensduur	50 jaar
Productgarantie	20 jaar
Milieuklasse	XA3, XC4, XD3, XS3, XF4
Hijsvoorziening	Geen, plaatsen met klem

Geconstrueerd conform

NEN-EN 1990 Eurocode 0	NEN-EN 206-1
NEN-EN 1991 Eurocode 1	NEN 8005
NEN-EN 1992 Eurocode 2	NEN 9997-2
NEN-EN 1997 Eurocode 7	Incl. nationale bijlagen

Productiewijze



Energie
neutraal



Gefilterd
hemelwater



Duurzame
grondstoffen



Recyclebare
materialen

Certificering

