

TYPE LR075H

Afmetingen

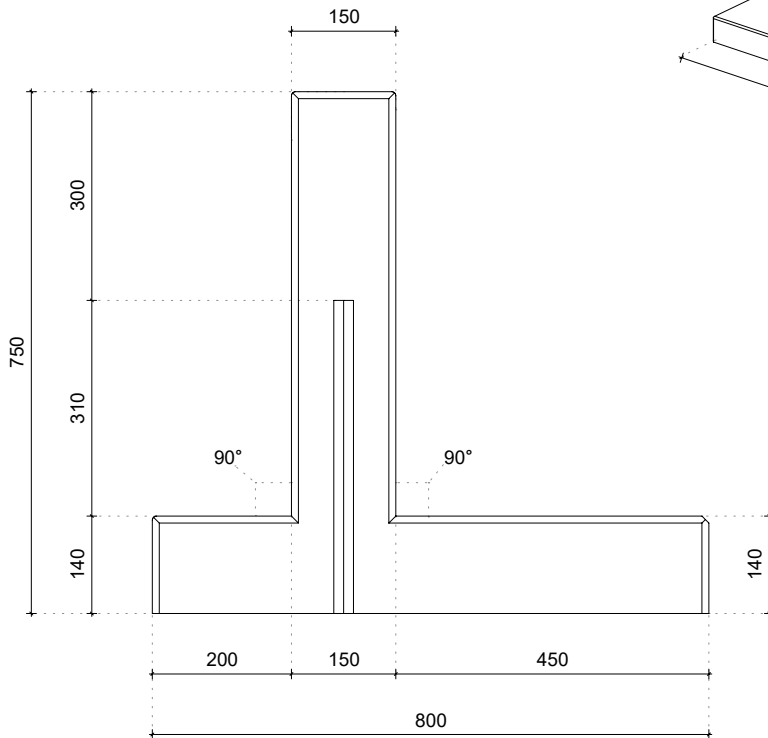

Details

Afgeronde bovenzijde

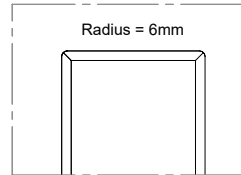

Koppelat-sparing

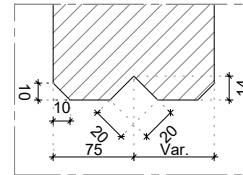

Verbinding elementen

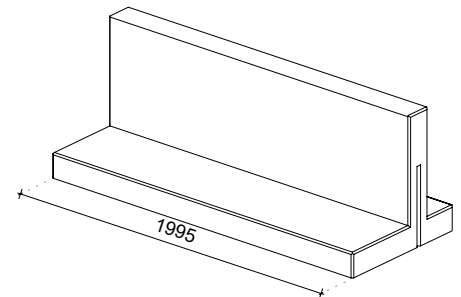
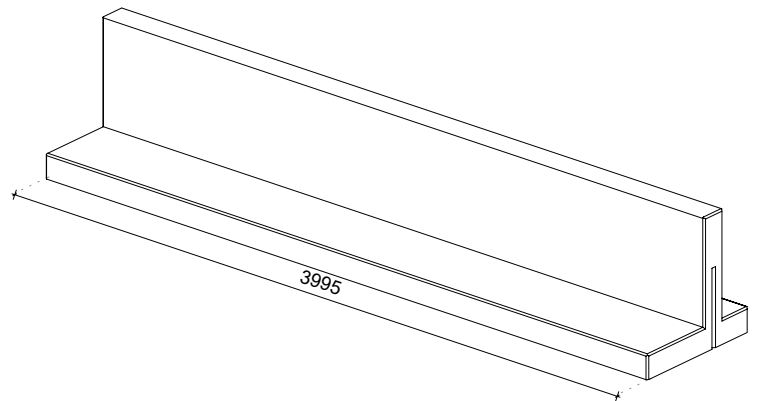
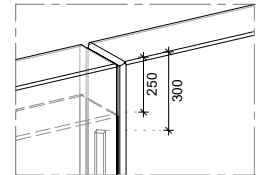

Technische details

| | |
|-------------------|--|
| Betonreceptuur | 2nd Generation self-compacting C60/75 |
| Wapeningsstaal | B500 |
| Gewicht | 1929kg (L = 3995mm) / 963kg (L = 1995mm) |
| Betondekking | 45mm |
| Maattolerantie | +/- 5mm |
| Zichtbetonklasse | Alle zichtzijdes klasse A (B1 op aanvraag) |
| Ontwerplevensduur | 100 jaar |
| Productgarantie | 10 jaar |
| Milieuklasse | XA3, XC4, XD3, XS3, XF4 |
| Hijsvoorziening | Geen, plaatsen met klem |

Geconstrueerd conform

| | |
|------------------------|--------------------------|
| NEN-EN 1990 Eurocode 0 | NEN-EN 206 |
| NEN-EN 1991 Eurocode 1 | NEN 8005 |
| NEN-EN 1992 Eurocode 2 | NEN 9997 |
| NEN-EN 1997 Eurocode 7 | Incl. nationale bijlagen |

Productiewijze



Energie
neutraal



Gefilterd
hemelwater



Duurzame
grondstoffen



Recyclebare
materialen

Certificering

