

# TYPE HOEKL050HAK

## Afmetingen

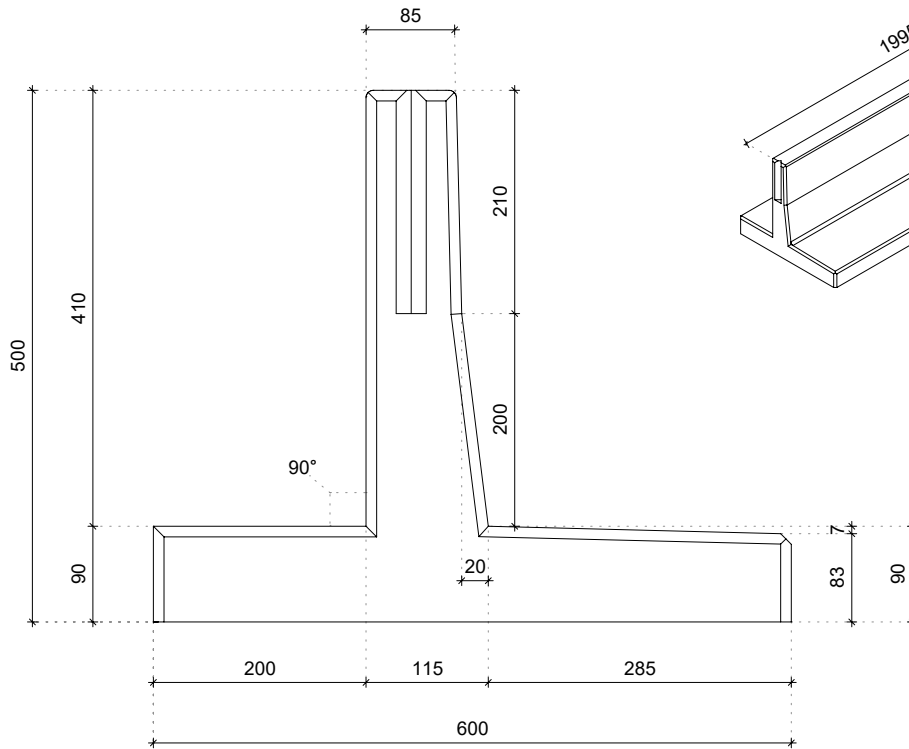

## Details

Afgeronde bovenzijde

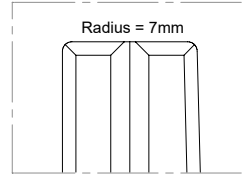

Koppellat-sparing

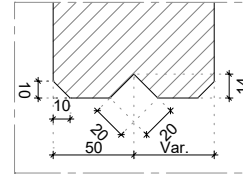

Verbinding elementen

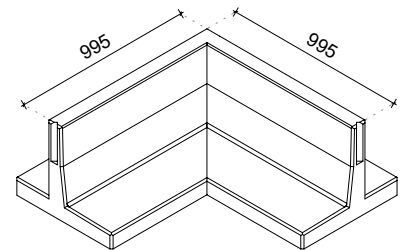
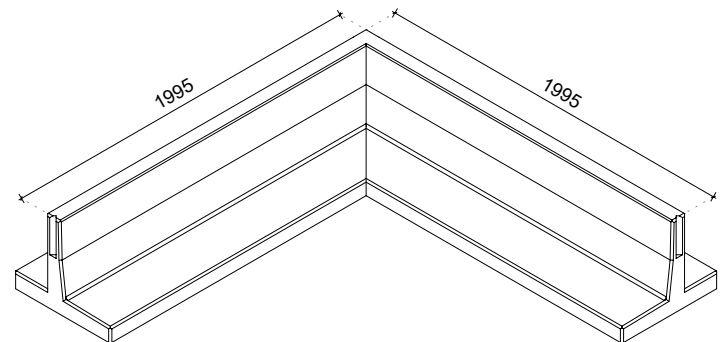
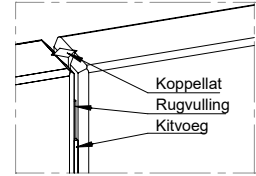

### Technische details

Betonreceptuur	3rd generation self-compacting C55/67
Wapeningsstaal	B500
Gewicht	840kg (L = 1995x1995mm) 400kg (L = 995x995mm)
Betondekking	30mm
Maattolerantie	+/- 5mm
Zichtbetonklasse	Alle zichtzijdes klasse A (B1 op aanvraag)
Ontwerplevensduur	50 jaar
Productgarantie	10 jaar
Milieuklasse	XA3, XC4, XD3, XS3, XF4
Hijsvoorziening	Geen, plaatsen met klem

### Geconstrueerd conform

NEN-EN 1990 Eurocode 0	NEN-EN 206
NEN-EN 1991 Eurocode 1	NEN 8005
NEN-EN 1992 Eurocode 2	NEN 9997
NEN-EN 1997 Eurocode 7	Incl. nationale bijlagen

### Productiewijze



Energie  
neutraal



Gefilterd  
hemelwater



Duurzame  
grondstoffen



Recyclebare  
materialen

### Certificering

