

TYPE LR175S

Afmetingen

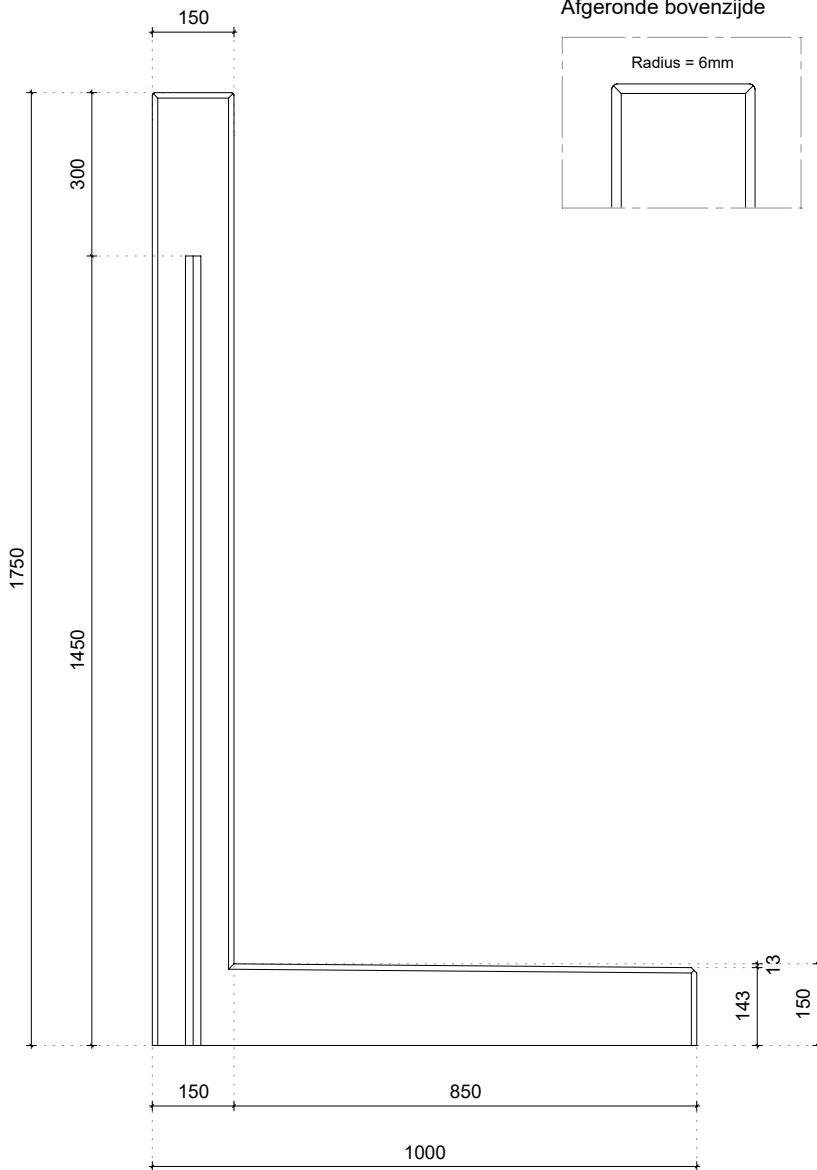

Details

Afgeronde bovenzijde

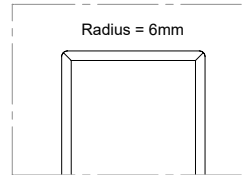

Koppelat-sparing

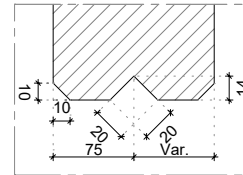

Verbinding elementen

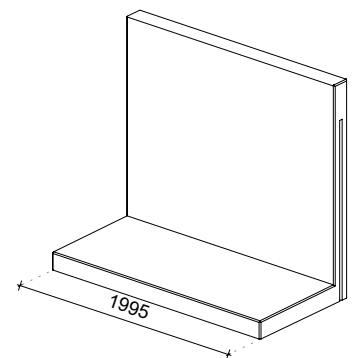
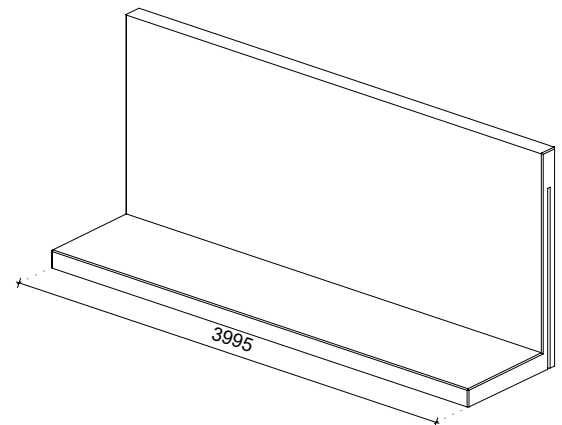
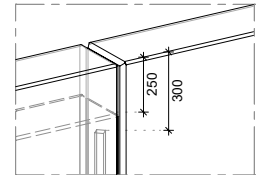

Technische details

Betonkwaliteit	C60/75 (zelfverdichtend hogesterktebeton)
Wapeningsstaal	B500
Gewicht	3714kg (L = 3995mm) / 1857kg (L = 1995mm)
Betondekking	45mm
Maattolerantie	+/- 5mm
Zichtbetonklasse	Alle zichtzijdes klasse A (B1 op aanvraag)
Ontwerplevensduur	100 jaar
Productgarantie	10 jaar
Milieuklasse	XA3, XC4, XD3, XS3, XF4
Hijsvoorziening	Geen, plaatsen met klem

Geconstrueerd conform

NEN-EN 1990 Eurocode 0	NEN-EN 206-1
NEN-EN 1991 Eurocode 1	NEN 8005
NEN-EN 1992 Eurocode 2	NEN 9997-2
NEN-EN 1997 Eurocode 7	Incl. nationale bijlagen

Productiewijze



Energie
neutraal



Gefilterd
hemelwater



Duurzame
grondstoffen



Recyclebare
materialen

Certificering

